



















TODO DE INOXIDABLE

CONEXIONES ORNAMENTALES EN ACERO INOXIDABLE



Índice

**TODO DE
INOXIDABLE**

	Sostenedores para barras	2
	Abrazaderas Verticales.....	3
	Conectores para Tubos.....	4-5
	Tapa Final.....	6-7
	Accesorios Universales.....	7
	Soportes de Pared.....	8-9
	Soportes para Pasamanos	10-11
	Soportes para Tubos	12-13
	Conectores Para Tubos y Barras.....	13
	Barras.....	14
	Discos y Bridas	15
	Embellecedores base	15
	Postes para Barandales	16
	Clips Para Cristales	17
	Hule para Clips	18
	Sujetadores Para Cristal.....	19
	Base para tubo, postes para cristal.....	19
	Bolas	20
	Tubos v Barras	20

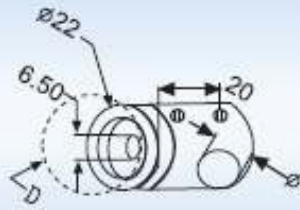
Pieza Número
D
 \varnothing

RHD0060404	1.5 pulgada	1/2 pulgada
RHD0070404	2.0 pulgada	1/2 pulgada
RHD0260504	1.5" \varnothing hueco	5/8" \varnothing
RHD0270504	2.0" \varnothing hueco	5/8" \varnothing
RHD0260604	1.5" \varnothing derecho	5/8" \varnothing
RHD0270604	2.0" \varnothing derecho	5/8" \varnothing
RHD0260704	1.5" \varnothing izquierdo	5/8" \varnothing
RHD0270704	2.0" \varnothing izquierdo	5/8" \varnothing

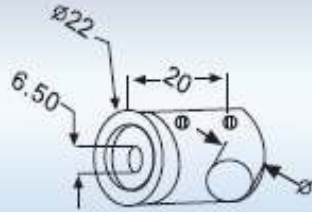
Pieza Número
D
 \varnothing

RHD0010404	Plano	1/2 pulgada
RHD0010104	Plano	10 mm
RHD0010204	Plano	12 mm
RHD0010304	Plano	14 mm

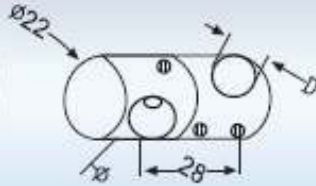
Pieza Número
D
 \varnothing

RSC0040404	1/2 pulgada	1/2 pulgada
RSC0010104	10 mm	10 mm
RSC0010204	10 mm	12 mm
RSC0010304	10 mm	14 mm
RSC0020204	12 mm	12 mm
RSC0020304	12 mm	14 mm
RSC0030304	14 mm	14 mm

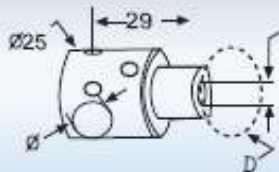
Pieza Número
D
 \varnothing

RHD1010204	Plano	12 mm
RHD1060404	1.5 pulgada	1/2 pulgada
RHD1070404	2.0 pulgada	1/2 pulgada
RHD1030204	42.4 mm	12 mm

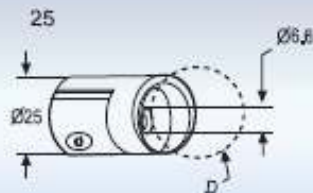
Pieza Número
D

RHD2010104	Plano
RHD2060104	1.5 pulgada
RHD2070104	2.0 pulgada
RHD2030104	42.4 mm

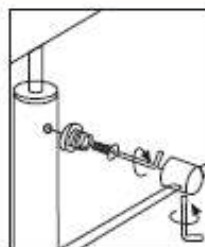

Pieza Número	Ø
RUC0010604	1.5 pulgada
RUC0010704	2.0 pulgada
RUC0010304	42.4 mm

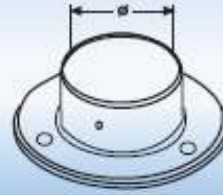

Pieza Número	Ø
RUC0040604	1.5 pulgada
RUC0040704	2.0 pulgada
RUC0040304	42.4 mm



Pieza Número	Ø
RUC0050604	1.5 pulgada
RUC0050704	2.0 pulgada
RUC0050304	42.4 mm

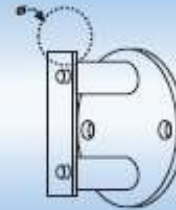

Pieza Número	Ø
RUC0020604	1.5 pulgada
RUC0020704	2.0 pulgada
RUC0020304	42.4 mm

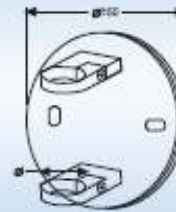

Pieza Número	Ø
RUC0030604	1.5 pulgada
RUC0030704	2.0 pulgada
RUC0030304	42.4 mm

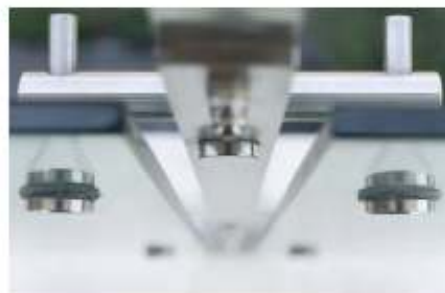



Pieza Número	Ø	T (Espesor)	H
REB1040304	1.5 pulgada	1.5 mm	45 mm
REB1050304	2.0 pulgada	1.5 mm	60 mm
REB1050104	2.0 pulgada	2.0 mm	60 mm
REB1020104	42.4 mm	2.0 mm	50 mm



Pieza Número	Ø	T (Espesor)	H
REB2040304	1.5 pulgada	1.5 mm	45 mm
REB2050304	2.0 pulgada	1.5 mm	60 mm
REB2050104	2.0 pulgada	2.0 mm	60 mm
REB2020104	42.4 mm	2.0 mm	50 mm



Pieza Número	Ø	T (Espesor)	H
REB3040304	1.5 pulgada	1.5 mm	45 mm
REB3050304	2.0 pulgada	1.5 mm	60 mm
REB3050104	2.0 pulgada	2.0 mm	60 mm
REB3020104	42.4 mm	2.0 mm	50 mm



Pieza Número	Ø	T (Espesor)	H
REB4040304	1.5 pulgada	1.5 mm	35 mm
REB4050304	2.0 pulgada	1.5 mm	45 mm
REB4050104	2.0 pulgada	2.0 mm	45 mm
REB4020104	42.4 mm	2.0 mm	38 mm

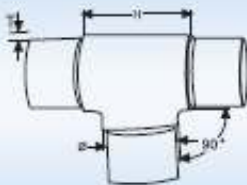

Pieza Número	Ø	T (Espesor)	H
REB5040304	1.5 pulgada	1.5 mm	52 mm
REB5050304	2.0 pulgada	1.5 mm	70 mm
REB5050104	2.0 pulgada	2.0 mm	70 mm
REB5020104	42.4 mm	2.0 mm	60 mm

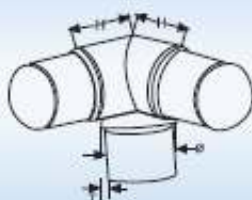

Pieza Número	Ø	T (Espesor)	H
REB6040304	1.5 pulgada	1.5 mm	45 mm
REB6050304	2.0 pulgada	1.5 mm	60 mm
REB6050104	2.0 pulgada	2.0 mm	60 mm
REB6020104	42.4 mm	2.0 mm	50 mm

Pieza Número	∅	T (Espesor)	H
REB7040304	1.5 pulgada	1.5 mm	45 mm
REB7050304	2.0 pulgada	1.5 mm	58 mm
REB7050104	2.0 pulgada	2.0 mm	58 mm
REB7020104	42.4 mm	2.0 mm	52 mm



Pieza Número	∅	T (Espesor)	H
REB8040304	1.5 pulgada	1.5 mm	24 mm
REB8050304	2.0 pulgada	1.5 mm	32 mm
REB8050104	2.0 pulgada	2.0 mm	32 mm
REB8020104	42.4 mm	2.0 mm	27 mm



Pieza Número	∅	T (Espesor)	H
REB9040304	1.5 pulgada	1.5 mm	
REB9050304	2.0 pulgada	1.5 mm	
REB9050104	2.0 pulgada	2.0 mm	
REB9020104	42.4 mm	2.0 mm	



Pieza Número	∅	T (Espesor)	H
REB1340304	1.5 pulgada	1.5 mm	57 mm
REB1350304	2.0 pulgada	1.5 mm	77 mm
REB1350104	2.0 pulgada	2.0 mm	77 mm
REB1320104	42.4 mm	2.0 mm	62 mm



Pieza Número	∅	T (Espesor)	H
REB1240304	1.5 pulgada	1.5 mm	52 mm
REB1250304	2.0 pulgada	1.5 mm	70 mm
REB1250104	2.0 pulgada	2.0 mm	70 mm
REB1220104	42.4 mm	2.0 mm	60 mm

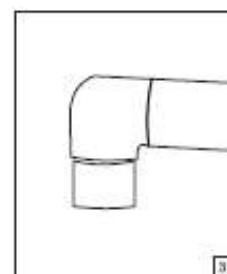
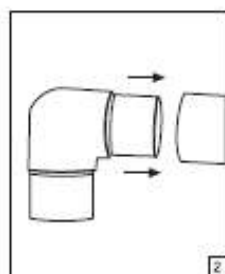
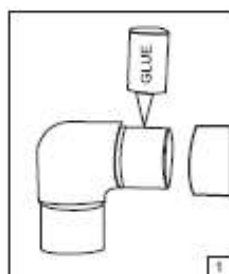
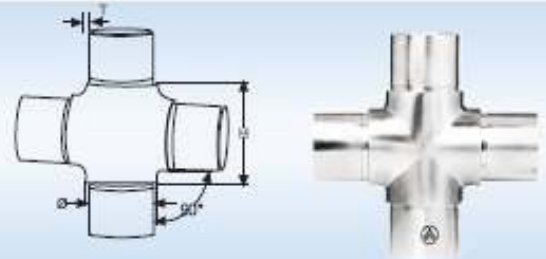



Pieza Número	Ø	T (Espesor)
REP0012404	1,5 pulgada	1,5 mm
REP0012504	2,0 pulgada	1,5 mm
REP0010504	2,0 pulgada	2,0 mm
REP0010204	42,4 mm	2,0 mm

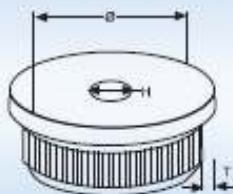

Pieza Número	Ø	T (Espesor)	H
REP0022404	1,5 pulgada	1,5 mm	M8
REP0022504	2,0 pulgada	1,5 mm	M8
REP0020504	2,0 pulgada	2,0 mm	M8
REP0020204	42,4 mm	2,0 mm	M8



Pieza Número	Ø	T (Espesor)
REP0032404	1,5 pulgada	1,5 mm
REP0032504	2,0 pulgada	1,5 mm
REP0030504	2,0 pulgada	2,0 mm
REP0030204	42,4 mm	2,0 mm



Pieza Número	Ø	T (Espesor)	H
REP0042404	1,5 pulgada	1,5 mm	M8
REP0042504	2,0 pulgada	1,5 mm	M8
REP0040504	2,0 pulgada	2,0 mm	M8
REP0040204	42,4 mm	2,0 mm	M8



Pieza Número	Ø	T (Espesor)
REP0052404	1,5 pulgada	1,5 mm
REP0052504	2,0 pulgada	1,5 mm
REP0050504	2,0 pulgada	2,0 mm
REP0050204	42,4 mm	2,0 mm



Pieza Número	Ø	T (Espesor)	H
REP0062404	1,5 pulgada	1,5 mm	M8
REP0062504	2,0 pulgada	1,5 mm	M8
REP0060504	2,0 pulgada	2,0 mm	M8
REP0060204	42,4 mm	2,0 mm	M8

Pieza Número	∅	T (Espesor)
REP0072404	1.5 pulgada	1.5 mm
REP0072504	2.0 pulgada	1.5 mm
REP0070504	2.0 pulgada	2.0 mm
REP0070204	42.4 mm	2.0 mm

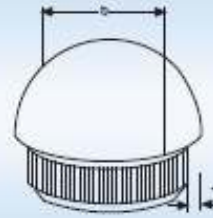

Accesorios Universales / Accesorios Universales

Pieza Número	d
RUA0011604	1.5 pulgada
RUA0011704	2.0 pulgada
RUA0011304	42.4 mm

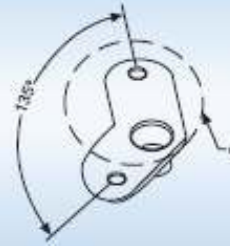

Pieza Número	d
RUA0012604	1.5 pulgada
RUA0012704	2.0 pulgada
RUA0012304	42.4 mm



Pieza Número	d
RUA0010104	plano
RUA0010604	1.5 pulgada
RUA0010704	2.0 pulgada
RUA0010304	42.4 mm

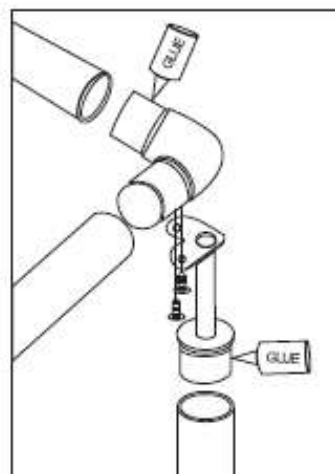

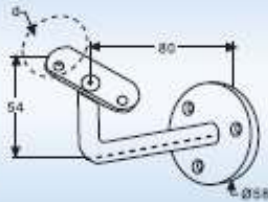

Pieza Número

d

RWB0100104	plano
RWB0100604	1,5 pulgada
RWB0100704	2,0 pulgada
RWB0100304	42,4 mm

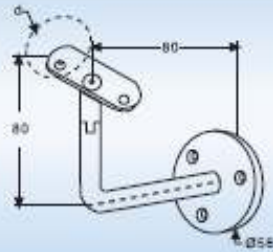

Pieza Número

d

RWB1100104	plano
RWB1100604	1,5 pulgada
RWB1100704	2,0 pulgada
RWB1100304	42,4 mm

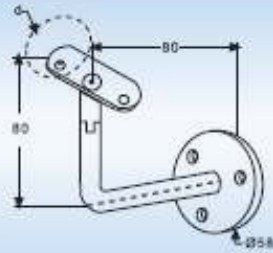

Pieza Número

d

RWB1101104	plano
RWB1101604	1,5 pulgada
RWB1101704	2,0 pulgada
RWB1101304	42,4 mm

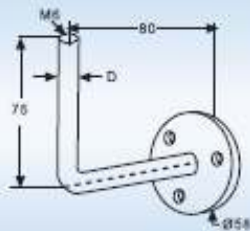

Pieza Número

d

RWB1300104	12 mm
RWB2310104	14 mm

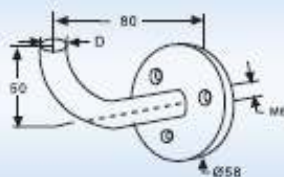

Pieza Número

d

RWB0300104	12 mm
------------	-------



Pieza Número	d
RWB0200104	plano
RWB0200604	1,5 pulgada
RWB0200704	2,0 pulgada
RWB0200304	42,4 mm

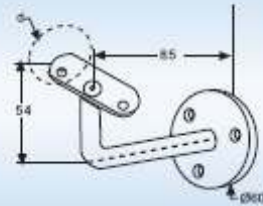

Pieza Número	d
RWB1200104	plano
RWB1200604	1,5 pulgada
RWB1200704	2,0 pulgada
RWB1200304	42,4 mm

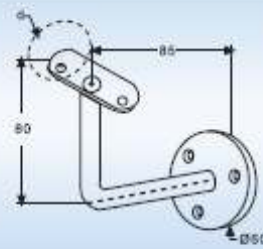

Pieza Número	d
RWB1201104	plano
RWB1201604	1,5 pulgada
RWB1201704	2,0 pulgada
RWB1201304	42,4 mm

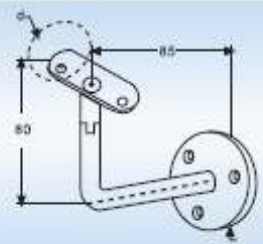

Pieza Número	d
RWB1300204	12 mm
RWB2310204	14 mm

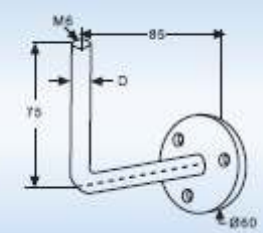

Pieza Número	d
RWB0300204	12 mm

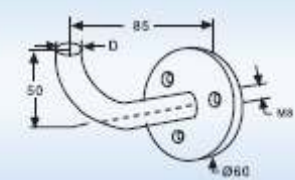

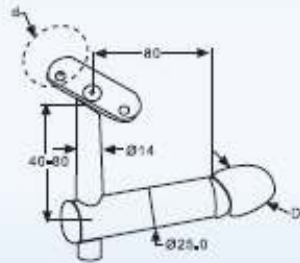

Pieza Número	Modelo	d	D
RHF0010104	A	plano	plano
RHF0010604	B	plano	1,5 pulgada
RHF0010704	B	plano	2,0 pulgada
RHF0010304	B	plano	42,4 mm
RHF0060104	C	1,5 pulgada	plano
RHF0070104	C	2,0 pulgada	plano
RHF0030104	C	42,4 mm	plano
RHF0060604	D	1,5 pulgada	1,5 pulgada
RHF0060704	D	1,5 pulgada	2,0 pulgada
RHF0070604	D	2,0 pulgada	1,5 pulgada
RHF0070704	D	2,0 pulgada	2,0 pulgada
RHF0030304	D	42,4 mm	42,4 mm

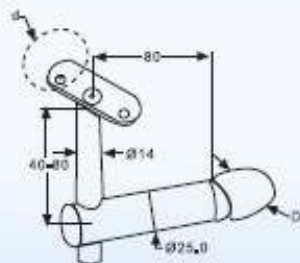
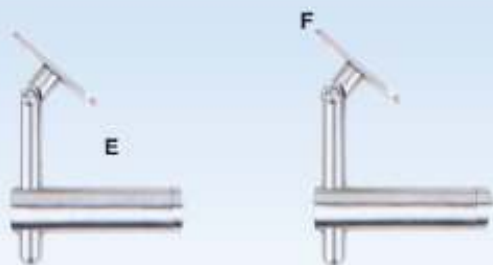

Pieza Número	Modelo	d	D
RHS0010104	E	plano	plano
RHS0010604	F	plano	1,5 pulgada
RHS0010704	F	plano	2,0 pulgada
RHS0010304	F	plano	42,4 mm
RHS0060104	G	1,5 pulgada	plano
RHS0070104	G	2,0 pulgada	plano
RHS0030104	G	42,4 mm	plano
RHS0060604	H	1,5 pulgada	1,5 pulgada
RHS0060704	H	1,5 pulgada	2,0 pulgada
RHS0070604	H	2,0 pulgada	1,5 pulgada
RHS0070704	H	2,0 pulgada	2,0 pulgada
RHS0030304	H	42,4 mm	

Pieza Número	d
RWF0010104	plano
RWF0010604	1.5 pulgada
RWF0010704	2.0 pulgada
RWF0010304	42.4 mm

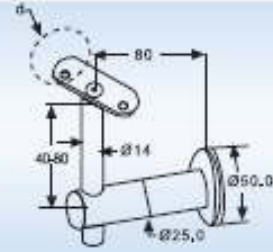

Pieza Número	d
RWS0010104	plano
RWS0010604	1.5 pulgada
RWS0010704	2.0 pulgada
RWS0010304	42.4 mm

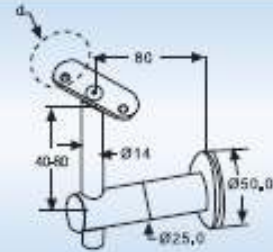

Pieza Número	d
RGF0010104	plano
RGF0010604	1.5 pulgada
RGF0010704	2.0 pulgada
RGF0010304	42.4 mm

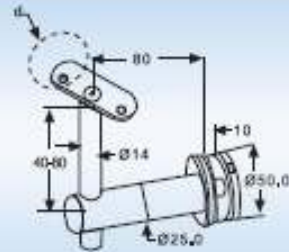

Pieza Número	d
RGS0010104	plano
RGS0010604	1.5 pulgada
RGS0010704	2.0 pulgada
RGS0010304	42.4 mm

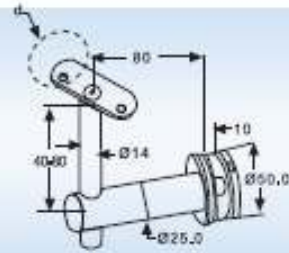

Pieza Número	d
RGF0020604	1.5 pulgada
RGF0020704	2.0 pulgada
RGF0020304	42.4 mm

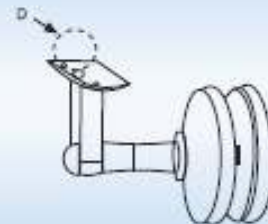

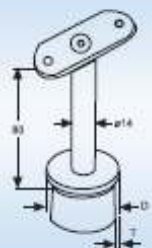

Pieza Número	D	T (Espesor)	d
RTF1050104	1.5 pulgada	1.5 pulgada	plano
RTF1060104	2.0 pulgada	2.0 pulgada	plano
RTF0060104	2.0 pulgada	2.0 pulgada	plano
RTF0030104	42.4 mm	2.0 mm	plano

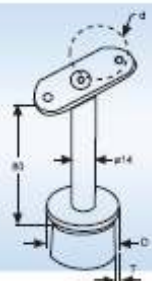

Pieza Número	D	T (Espesor)	d
RTF1060604	1.5 pulgada	1.5 mm	1.5 pulgada
RTF1060704	1.5 pulgada	1.5 mm	2.0 pulgada
RTF1070604	2.0 pulgada	1.5 mm	1.5 pulgada
RTF1070704	2.0 pulgada	1.5 mm	2.0 pulgada
RTF0070604	2.0 pulgada	2.0 mm	1.5 pulgada
RTF0070704	2.0 pulgada	2.0 mm	2.0 pulgada
RTF0030304	42.4 mm	2.0 mm	42.4 mm



Pieza Número	D	T (Espesor)	d
RTF1051504	1.5 pulgada	1.5 mm	1.5 pulgada
RTF1051604	1.5 pulgada	1.5 mm	2.0 pulgada
RTF1061504	2.0 pulgada	1.5 mm	1.5 pulgada
RTF1061604	2.0 pulgada	1.5 mm	2.0 pulgada
RTF0061504	2.0 pulgada	2.0 mm	1.5 pulgada
RTF0061604	2.0 pulgada	2.0 mm	2.0 pulgada
RTF0031304	42.4 mm	2.0 mm	42.4 mm

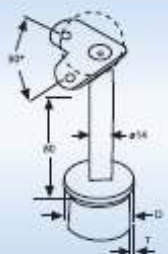

Pieza Número	D	T (Espesor)	d
RTF1052504	1.5 pulgada	1.5 mm	1.5 pulgada
RTF1052604	1.5 pulgada	1.5 mm	2.0 pulgada
RTF1062504	2.0 pulgada	1.5 mm	1.5 pulgada
RTF1062604	2.0 pulgada	1.5 mm	2.0 pulgada
RTF0062504	2.0 pulgada	2.0 mm	1.5 pulgada
RTF0062604	2.0 pulgada	2.0 mm	2.0 pulgada
RTF0032304	42.4 mm	2.0 mm	42.4 mm

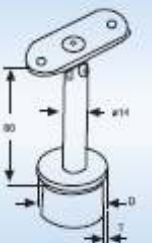

Pieza Número	D	T (Espesor)	d
RTS1060104	1.5 pulgada	1.5 mm	plano
RTS1070104	2.0 pulgada	1.5 mm	plano
RTS1070104	2.0 pulgada	2.0 mm	plano
RTS0030104	42.4 mm	2.0 mm	plano

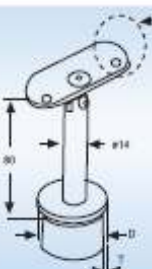

Pieza Número	D	T (Espesor)	d
RTS1060604	1.5 pulgada	1.5 mm	1.5 pulgada
RTS1060704	1.5 pulgada	1.5 mm	2.0 pulgada
RTS1070604	2.0 pulgada	1.5 mm	1.5 pulgada
RTS1070704	2.0 pulgada	1.5 mm	2.0 pulgada
RTS0070604	2.0 pulgada	2.0 mm	1.5 pulgada
RTS0070704	2.0 pulgada	2.0 mm	2.0 pulgada
RTS0030304	42.4 mm	2.0 mm	42.4 mm

Pieza Número	D	T (Espesor)	d
RTF2051504	1,5 pulgada	1,5 mm	1,5 pulgada
RTF2051604	1,5 pulgada	1,5 mm	2,0 pulgada
RTF2061504	2,0 pulgada	1,5 mm	1,5 pulgada
RTF2061604	2,0 pulgada	1,5 mm	2,0 pulgada
RTF2060504	2,0 pulgada	2,0 mm	1,5 pulgada
RTF2060604	2,0 pulgada	2,0 mm	2,0 pulgada
RTF2030304	42,4 mm	2,0 mm	42,4 mm

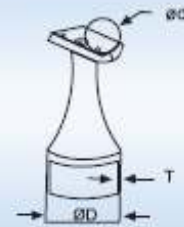

Pieza Número	D	T (Espesor)	d
RTS2051504	1,5 pulgada	1,5 mm	1,5 pulgada
RTS2051604	1,5 pulgada	1,5 mm	2,0 pulgada
RTS2061504	2,0 pulgada	1,5 mm	1,5 pulgada
RTS2061604	2,0 pulgada	1,5 mm	2,0 pulgada
RTS2060504	2,0 pulgada	2,0 mm	1,5 pulgada
RTS2060604	2,0 pulgada	2,0 mm	2,0 pulgada
RTS2030304	42,4 mm	2,0 mm	42,4 mm



Pieza Número	D	T (Espesor)	d
RTR0260104	1,5 pulgada	1,5 mm	plano
RTR0270104	2,0 pulgada	1,5 mm	plano
RTR0070104	2,0 pulgada	2,0 mm	plano
RTR0030104	42,4 mm	2,0 mm	plano

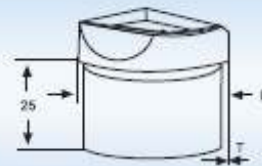

Pieza Número	D	T (Espesor)	d
RTR0260604	1,5 pulgada	1,5 mm	1,5 pulgada
RTR0260704	1,5 pulgada	1,5 mm	2,0 pulgada
RTR0270604	2,0 pulgada	1,5 mm	1,5 pulgada
RTR0270704	2,0 pulgada	1,5 mm	2,0 pulgada
RTR0070604	2,0 pulgada	2,0 mm	1,5 pulgada
RTR0070704	2,0 pulgada	2,0 mm	2,0 pulgada
RTR0030304	42,4 mm	2,0 mm	42,4 mm

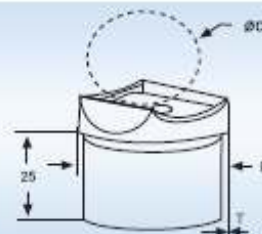

Conectores Para Tubos y Barras

Pieza Número	Ø	T (Espesor)	d
REB2110104	16,0 mm	1,0 mm	11 mm



Pieza Número	Ø	H
REB2120104	10 mm	35 mm
REB2130104	12 mm	36 mm
REB2140104	14 mm	37 mm
REB2150704	1/2 pulgada	36 mm





Pieza Número	Bar Ø	Hilo de Agujero	Hilo de Agujero
RSB0012204	12 mm	M6	M8
RSB0022204	14 mm	M6	M8



Pieza Número	Bar Ø	Hilo de Agujero	Hilo de Agujero
RFB0012204	12 mm	M6	M8
RFB0022204	14 mm	M6	M8

RFB0032204	12 mm	M6	M8
------------	-------	----	----



Pieza Número	Bar Ø	Hilo de Agujero	Hilo de Agujero	Hilo de Agujero
RFP0012104	12 mm	M8	M6	
RFP0022104	14 mm	M8	M6	
RFP0012204	12 mm		M6	M8
RFP0022204	14 mm		M6	M8

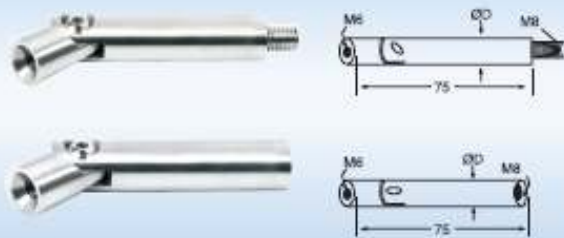

Pieza Número	Bar Ø	Hilo de Agujero	Hilo de Agujero	Hilo de Agujero
RSP0012104	12 mm	M8	M6	
RSP0022104	14 mm	M8	M6	
RSP0012204	12 mm		M6	M8
RSP0022204	14 mm		M6	M8

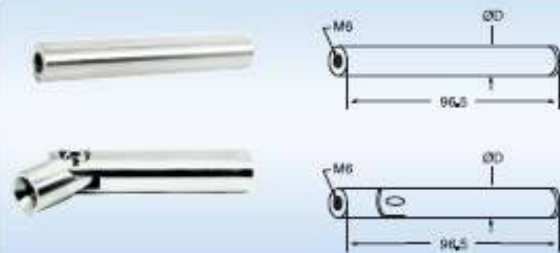

Pieza Número	Bar Ø	Hilo de Agujero
RFP0122004	14 mm	M6
RSP0122004	14 mm	M6



Pieza Número	Bar Ø	Hilo de Agujero	Hilo de Agujero
RFP0112204	12 mm	M6	M8

Pieza Número	Ø	Espesor
RPL0420404	42 mm	4,0 mm
RPL0480404	48 mm	4,0 mm
RPL0580104	58 mm	5,0 mm
RPL0700104	68 mm	5,0 mm
RPL0800604	80 mm	6,0 mm
RPL1000104	100 mm	6,0 mm
RPL1001004	100 mm	10,0 mm
RPL1201004	120 mm	10,0 mm

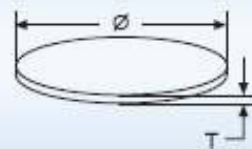

Pieza Número	Ø	Espesor	Agujero
RPW0581104	58 mm	5,0 mm	2x6,5 mm
RPW0581204	58 mm	5,0 mm	3x6,5 mm
RPW0701104	68 mm	5,0 mm	2x6,5 mm
RPW0701204	68 mm	5,0 mm	3x6,5 mm
RPW0801104	80 mm	6,0 mm	2x8,5 mm
RPW0801204	80 mm	6,0 mm	3x8,5 mm
RPW1001104	100 mm	6,0 mm	2x11 mm
RPW1001204	100 mm	6,0 mm	3x11 mm
RPW1201104	120 mm	10,0 mm	2x13 mm
RPW1201204	120 mm	10,0 mm	3x13 mm

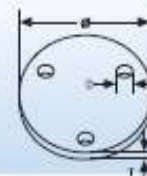
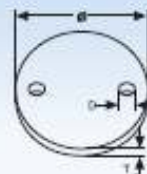

Pieza Número	Ø	Espesor	Agujero Ext.	Agujero Int.
RPW0701304	70 mm	6,0 mm	2x8,5 mm	10,5 mm
RPW0701404	70 mm	6,0 mm	3x8,5 mm	10,5 mm
RPW1001404	100 mm	6,0 mm	2x11 mm	43 mm
RPW1001504	100 mm	6,0 mm	3x11 mm	43 mm
RPW1201304	120 mm	10,0 mm	2x13 mm	43 mm
RPW1201504	120 mm	10,0 mm	3x13 mm	43 mm
RPW1001604	100 mm	6,0 mm	2x11 mm	1,5 pulgada
RPW1201704	120 mm	10,0 mm	3x13 mm	2,0 pulgada

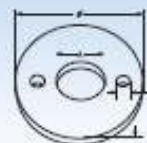

Embellecedores Base

Pieza Número	Ø	D	H
RPC0600104	60 mm	12,5 mm	12 mm
RPC0760204	76 mm	12,5 mm	12 mm
RPC0850204	85 mm	43,0 mm	16 mm
RPC1050104	105 mm	43,0 mm	25 mm
RPC1051104	105 mm	51,5 mm	25 mm
RPC1051204	105 mm	61,0 mm	25 mm
RPC0761304	76 mm	1,5 pulgada	12 mm
RPC0761404	76 mm	2,0 pulgada	12 mm
RPC1051304	105 mm	1,5 pulgada	25 mm
RPC1051404	105 mm	2,0 pulgada	25 mm

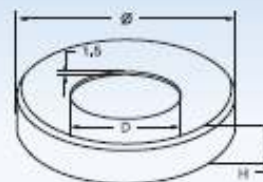



Pieza Número	Ø	T
AIX1	1 1/2" X 85 CM.	1/4" esp.



Pieza Número	Ø	T
AIX2	1 1/2" x 85 CM.	1/4" esp.



Pieza Número	Ø	T
CIX1	2" X 85 CM.	2,0 mm
CIPVG16100		



Pieza Número	Ø	T
CIX2	2" X 2" x 85 CM.	2,00 mm
CIPVC18200		

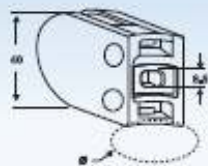

Fit for 6mm to 8mm Glass

Pieza Número	Material	Diametro de tubo
RGC101XX04	SS 304	plano
RGC106XX04	SS 304	1.5 pulgada
RGC103XX04	SS 304	42.4 mm
RGC101XX16	SS 316	plano
RGC106XX16	SS 316	1.5 pulgada
RGC103XX16	SS 316	42.4 mm
RGC101XXZM	Zamak	plano
RGC106XXZM	Zamak	1.5 pulgada
RGC103XXZM	Zamak	42.4 mm

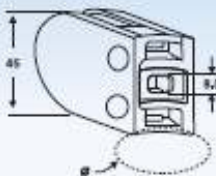

Fit for 6mm to 12mm Glass

Pieza Número	Material	Diametro de tubo
RGC201XX04	SS 304	plano
RGC207XX04	SS 304	1.5 pulgada
RGC203XX04	SS 304	42.4 mm
RGC201XX16	SS 316	plano
RGC207XX16	SS 316	2.0 pulgada
RGC203XX16	SS 316	42.4 mm
RGC201XXZM	Zamak	plano
RGC207XXZM	Zamak	2.0 pulgada
RGC203XXZM	Zamak	42.4 mm

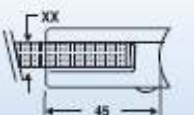
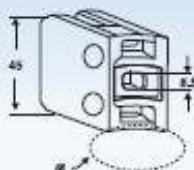

Fit for 6mm to 12mm Glass

Pieza Número	Material	Diametro de tubo
RGC301XX04	SS 304	plano
RGC306XX04	SS 304	1.5 pulgada
RGC303XX04	SS 304	42.4 mm
RGC301XX16	SS 316	plano
RGC306XX16	SS 316	1.5 pulgada
RGC303XX16	SS 316	42.4 mm
RGC301XXZM	Zamak	plano
RGC306XXZM	Zamak	1.5 pulgada
RGC303XXZM	Zamak	42.4 mm

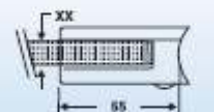
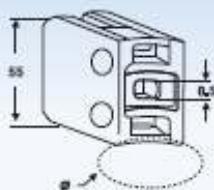

Fit for 6mm to 12mm Glass

Pieza Número	Material	Diametro de tubo
RGC401XX04	SS 304	plano
RGC407XX04	SS 304	1.5 pulgada
RGC403XX04	SS 304	42.4 mm
RGC401XX16	SS 316	plano
RGC407XX16	SS 316	1.5 pulgada
RGC403XX16	SS 316	42.4 mm
RGC401XXZM	Zamak	plano
RGC407XXZM	Zamak	1.5 pulgada
RGC403XXZM	Zamak	42.4 mm

Pieza Número	Espesor de Cristal	Para Modelo
RGR10001RB	6 mm	GC, 101 / GC, 103 / GC, 106
RGR10002RB	8 mm	GC, 101 / GC, 103 / GC, 106
RGR10003RB	10 mm	GC, 101 / GC, 103 / GC, 106
RGR10004RB	12 mm	GC, 101 / GC, 103 / GC, 106
RGR20001RB	6 mm	GC, 201 / GC, 203 / GC, 207
RGR20002RB	8 mm	GC, 201 / GC, 203 / GC, 207
RGR20003RB	10 mm	GC, 201 / GC, 203 / GC, 207
RGR20004RB	12 mm	GC, 201 / GC, 203 / GC, 207



Pieza Número	Espesor de Cristal	Para Modelo
RGR30001RB	6 mm	GC, 301 / GC, 303 / GC, 306
RGR30002RB	8 mm	GC, 301 / GC, 303 / GC, 306
RGR30003RB	10 mm	GC, 301 / GC, 303 / GC, 306
RGR30004RB	12 mm	GC, 301 / GC, 303 / GC, 306
RGR40001RB	6 mm	GC, 401 / GC, 403 / GC, 407
RGR40002RB	8 mm	GC, 401 / GC, 403 / GC, 407
RGR40003RB	10 mm	GC, 401 / GC, 403 / GC, 407
RGR40004RB	12 mm	GC, 401 / GC, 403 / GC, 407



Todos los clips del cristal también disponibles en zamak (aleación del cinc) y en AISI 316 (V44)



Sujetadores para Cristal

Pieza Número	Ø
RGH0300104	plano
RGH0300604	1,5 pulgada
RGH0300704	2,0 pulgada
RGH0300304	42,4 mm

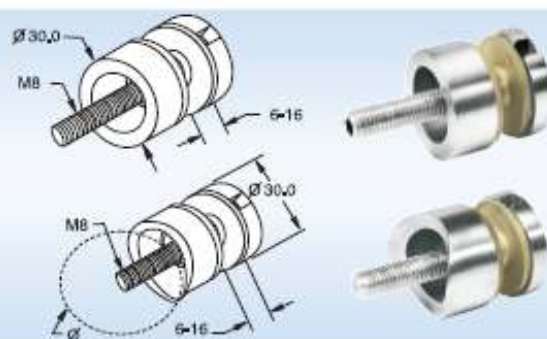



Base para tubo

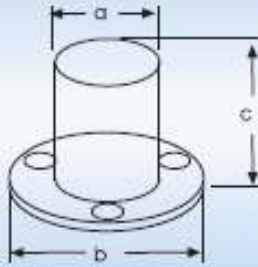

Pieza Número

d

CI-BA00150

1 1/2" cal 16 y cal 18

CI-BA00200

2" cal 16 y cal 18



Pieza Número

d

CI-PV16100

1" cal 16 Poste para cristal a pared o piso

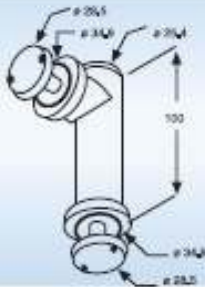

Pieza Número

d

CI-PVE16100

1" cal 16 Poste para cristal a cristal

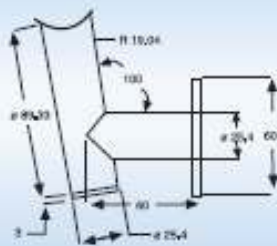

Pieza Número

d

CI-PPP16100

1" cal 16 Poste para cristal a cristal

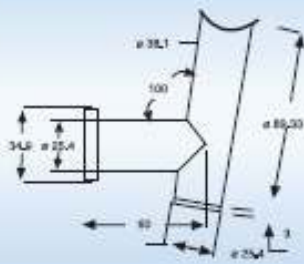

Pieza Número

d

CI-PVP16100

1" cal 16 Soporte de pasamanos a cristal



Pieza Número	Ø	D
RBH0400204	40 mm	M8
RBH0500204	50 mm	M8
RBH0600304	60 mm	M8
RBH0700304	70 mm	M8
RBH0800304	80 mm	M10
RBH0900404	90 mm	M10
RBH1000404	100 mm	M10
RBH1200404	120 mm	M10
RBH1500504	150 mm	M14
RBH2000504	200 mm	M14



Pieza Número	Ø	D
RBS0150204	15 mm	M6
RBS0200204	20 mm	M6
RBS0250204	25 mm	M6
RBS0300204	30 mm	M6
RBS0200404	20 mm	10,2 mm
RBS0200504	20 mm	12,2 mm
RBS0250504	25 mm	12,2 mm
RBS0250604	25 mm	14,2 mm
RBS0300504	30 mm	12,2 mm
RBS0300604	30 mm	14,2 mm



Pieza Número	Ø	D
RBH0501504	50 mm	1,5 pulgada
RBH0601604	60 mm	2,0 pulgada
RBH0551204	55 mm	42,4 mm

Tubos y Barras



Pieza Número	D	Espesor
Tubo Ornamental Satinado P180		
Tubo Ornamental Satinado P180	2" x 6,10 mts.	cal 18
Tubo Ornamental Texturizado	2" x 5,00 mts.	cal 20
Tubo Ornamental Satinado P180	1 1/2" x 6,10 mts.	cal 16
Tubo Ornamental Satinado P180	1 1/2" x 6,10 mts.	cal 18
Tubo Ornamental Texturizado	1 1/2" x 5,00 mts.	cal 20
Tubo Ornamental Texturizado	1" x 4,00 mts.	cal 20



Pieza Número	D	Espesor
Tubo Ornamental Texturizado	5/8" x 5,00 mts.	
Tubo Ornamental Satinado P180	5/8" x 5,00 mts.	cal 20
Barra Sólida	1/2"	